

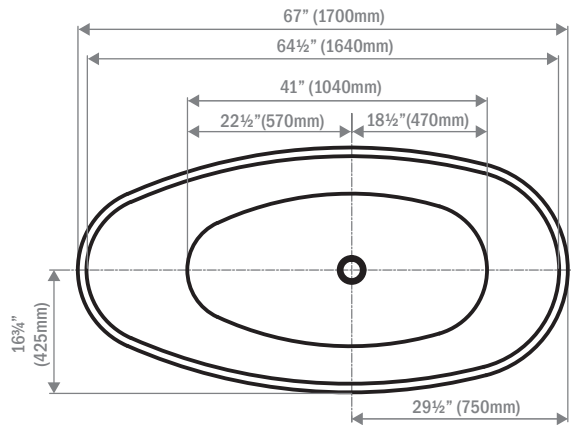

**RENOVATION
FREESTANDING
BATHTUB**

**BAIGNOIRE
AUTOPROTANTE
DE RÉNOVATION**



TOP VIEW
VUE DE DESSUS

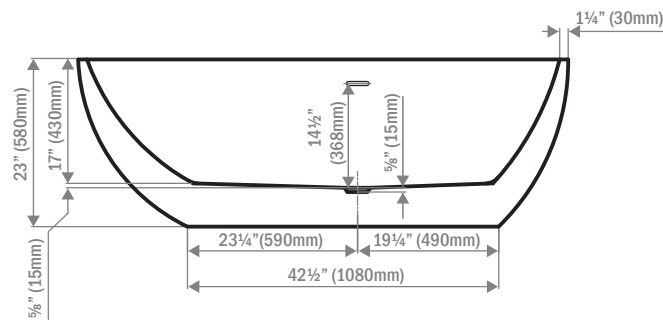

FRONT VIEW
VUE DE FACE

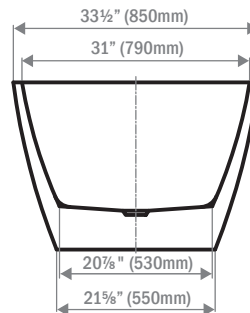

SIDE VIEW
VUE DE CÔTÉ

* Dimensions may vary +/- 1/4" (6mm) / Les dimensions peuvent varier de +/- 1/4" (6mm)

BT-6840-67

gallons to overflow / gallon au trop plein
69.2

packaging dimension d'emballage
68 1/2" x 35" x 24 1/2"

approximated weight / Poids approximatif
84 lbs

weight with water / poids rempli d'eau
661 lbs

bathing well at sump /
dimension interieur au rebord
41" x 20 7/8"

bathing well at rim /
dimension au bord du bain
64 1/2" x 31"

Overflow height / Hauteur du trop-plein
14 1/2"

Compliance Certifications:

Uniform Plumbing Code
National Plumbing Code of Canada
CSA B45.5-17/IAPMO Z124-2017



Pure acrylic construction reinforced by fiberglass
Construction en acrylique renforcée de fibre de verre

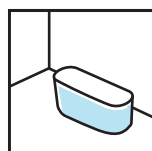

Freestanding installation
autoprotante

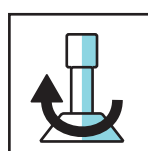

Adjustable feet
Pattes ajustables

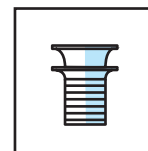

Pop-up drain included
Drain pop-up inclus

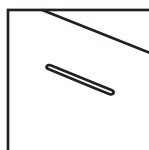

Linear overflow
Trop plein linéaire



cUPC Certified
Certifié cUPC